The slide features a background of green leaves with water droplets and a white hexagonal grid pattern. A central semi-transparent box contains the title and subtitle. At the bottom, there is a black banner with the Western Oregon University logo, a disclaimer, and a red 'TOGETHER WE SUCCEED' logo.

**Biochemical Energy  
Generation and Utilization**

**Part 1: The ATP Currency and Brain  
Function**

 **Western Oregon**  
UNIVERSITY

If you have a disability that may require some accommodation in order to participate in a WOU activity, please notify Disability Services at 503-838-8250 or ods@wou.edu at least 72 hours in advance.

**TOGETHER WE  
SUCCEED**

Welcome to our next major unit in energy metabolism, Biochemical Energy Generation and Utilization. In this section we will discuss why ATP is such an important energy molecule and the role it plays in neuronal signaling.

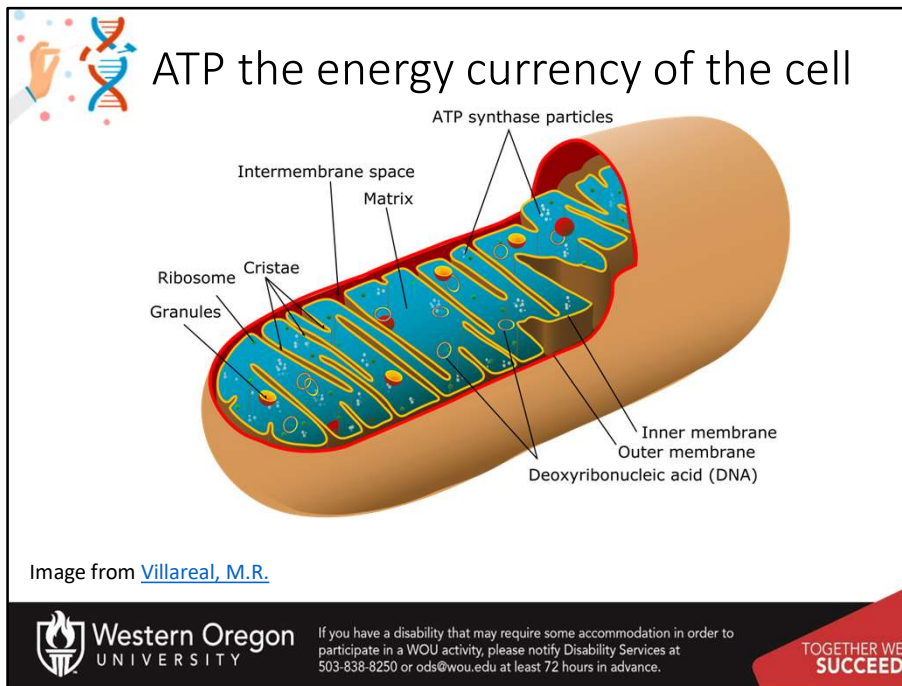

Many times throughout your education in Biology and Chemistry, you have undoubtedly been told that ATP is the energy currency of the cell and that the mitochondria is the energy powerhouse, where ATP production occurs. In this course, we will spend a significant amount of time dedicated to understanding these processes. But before we focus on the production of ATP, let's get a better sense for why ATP and the other nucleotide triphosphates are so important in cellular function.

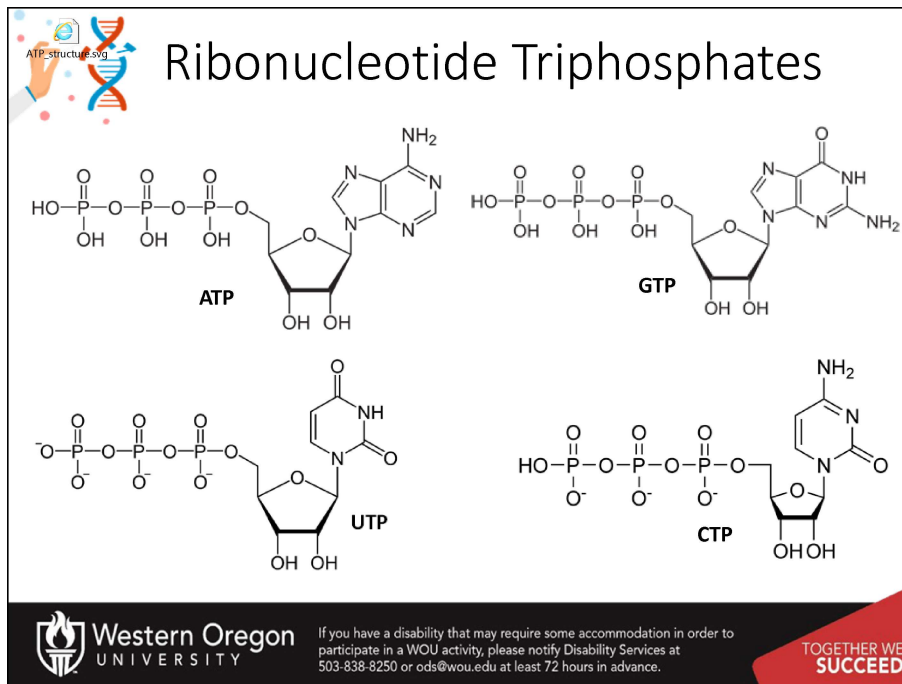

All of the ribonucleotide phosphates that serve as the monomer subunits for the synthesis of RNA, also have a major role in energy-requiring processes within the body. ATP is the predominant one, but as we have seen in our discussions on glycogen regulation and biosynthesis, GTP and UTP are also utilized in processes requiring energy. Similarly, some biochemical reactions also require CTP as a cofactor.



## What is NTP Currency Used For?

- Enzymatic Reactions (Energy Potential)
- Phosphate Donor (Kinase-specific Reactions)
- Cellular signaling pathways
- Neuronal Signaling
- Movement
  - Molecular level
    - Across membranes
    - Internally through the cell (through cytoplasm; transfer to organelle, etc)
  - Gross motor level (muscle contraction)



Western Oregon  
UNIVERSITY

If you have a disability that may require some accommodation in order to participate in a WOU activity, please notify Disability Services at 503-838-8250 or ods@wou.edu at least 72 hours in advance.

TOGETHER WE  
SUCCEED

NTP currency is utilized to perform a great many functions within the body.



## What is NTP Currency Used For?

- **Enzymatic Reactions (Energy Potential)**
- Phosphate Donor (Kinase-specific Reactions)
- Cellular signaling pathways (movement; messengers)
- Neuronal Signaling
- Movement
  - Molecular level
    - Across membranes
    - Internally through the cell (through cytoplasm; transfer to organelle)
    - Assembly of structures (ribosome; signaling complexes, etc)
  - Gross motor level (muscle contraction)



Western Oregon  
UNIVERSITY

If you have a disability that may require some accommodation in order to participate in a WOU activity, please notify Disability Services at 503-838-8250 or ods@wou.edu at least 72 hours in advance.

TOGETHER WE  
SUCCEED

The first, is the utilization of the energy released by NTP hydrolysis to drive forward enzymatic reactions that would normally be unfavorable and endergonic.

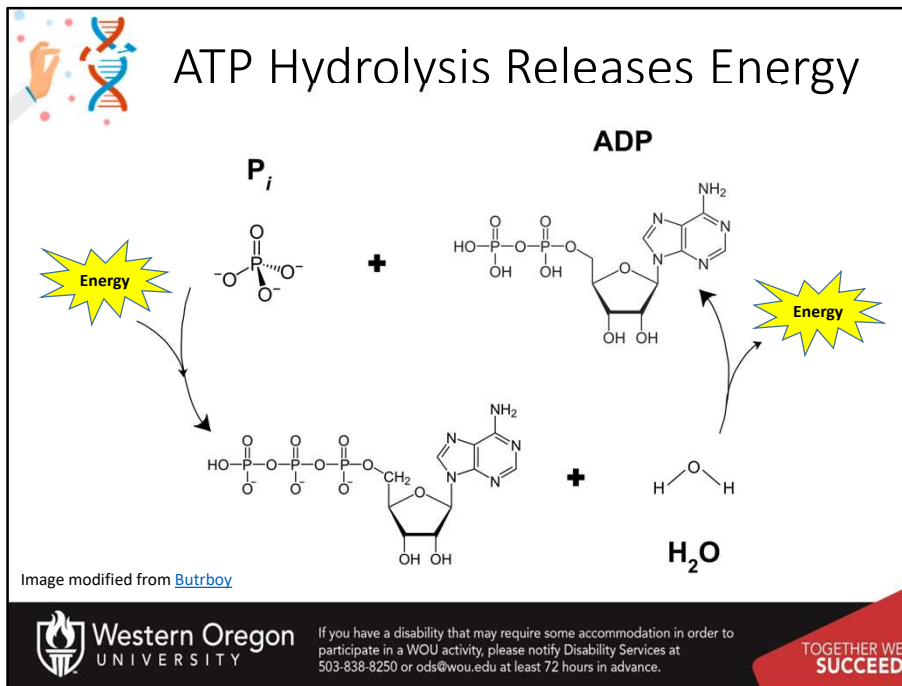

Recall that the hydrolysis of ATP to ADP + Pi releases a lot of energy. In fact, the hydrolysis of one mole of ATP will release approximately -7.3 kcal/mol (-30.5 kJ/mol). When coupled with other reactions, this energy release can often drive reactions forward.

 NDP-intermediates

- UDP-Glucose Pyrophosphorylase catalyzes the formation of UDP-Glucose from UTP and Glucose 1-phosphate

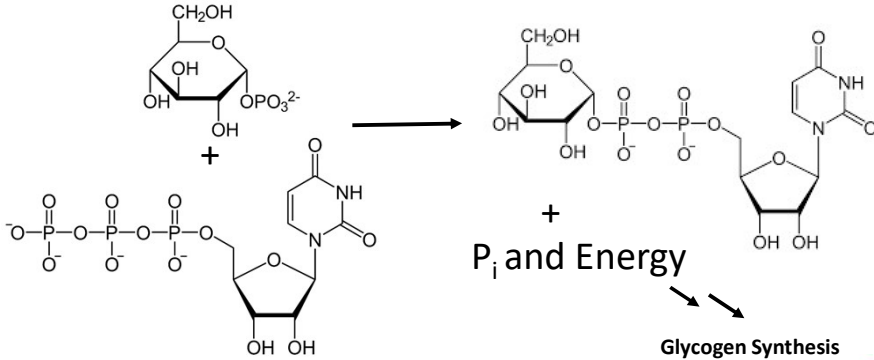

**Glycogen Synthesis**

 **Western Oregon UNIVERSITY**

If you have a disability that may require some accommodation in order to participate in a WOU activity, please notify Disability Services at 503-838-8250 or ods@wou.edu at least 72 hours in advance.

**TOGETHER WE SUCCEED**

We saw an example of this in glycogen biosynthesis. The glycogen synthase enzyme requires that the glucose molecule to be added to the nascent glycogen chain, must first be activated to the UDP-glucose form. The UDP- serves as a good leaving group in the formation of the glycosidic linkage between the 1 position carbon of the incoming glucose and the 4-position oxygen of the glycogen chain. Otherwise, if the anomeric hydroxyl group of glucose needed to be hydrolyzed in an unmodified form, the formation of the glycosidic bond would be an endergonic and nonspontaneous reaction. Many enzymatic reactions require the activation of one of the substrates by making an NTP-derivative. Can you think of other reactions that use this mechanism? Watch for new ones in the coming lessons.



## Coenzyme A

- Coenzyme A is also commonly used as a substrate/intermediate in reactions

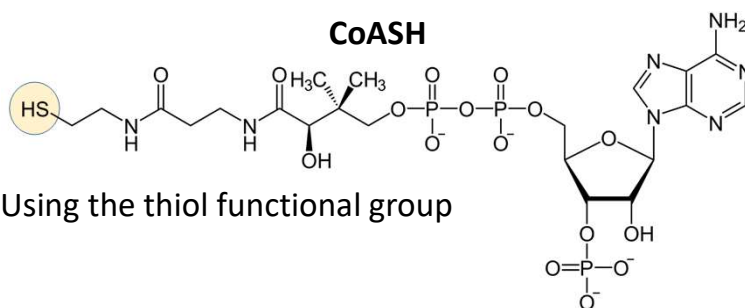

- Using the thiol functional group



Western Oregon  
UNIVERSITY

If you have a disability that may require some accommodation in order to participate in a WOU activity, please notify Disability Services at 503-838-8250 or ods@wou.edu at least 72 hours in advance.

TOGETHER WE  
SUCCEED

In addition to the familiar NTPs, Coenzyme A is a modified nucleotide containing molecule that is also utilized as an intermediate and/or substrate in many reactions. The thiol functional group serves as the attachment point for these reactions. You will often see it abbreviated as CoASH in reactions. The CoA part for Coenzyme A, and then the inclusion of the thiol functional group which is the reactive portion of the molecule, rather than the phosphate groups seen in the NTPs





## What is NTP Currency Used For?

- Enzymatic Reactions (Energy Potential)
- **Phosphate Donor (Kinase-specific Reactions)**
- Cellular signaling pathways (movement; messengers)
- Neuronal Signaling
- Movement
  - Molecular level
    - Across membranes
    - Internally through the cell (through cytoplasm; transfer to organelle)
    - Assembly of structures (ribosome; signaling complexes, etc)
  - Gross motor level (muscle contraction)



Western Oregon  
UNIVERSITY

If you have a disability that may require some accommodation in order to participate in a WOU activity, please notify Disability Services at 503-838-8250 or ods@wou.edu at least 72 hours in advance.

TOGETHER WE  
SUCCEED

NTPs can also serve as phosphate donors for kinase reactions.



## Hexokinase

- When glucose enters the cell it is rapidly converted to glucose 6-phosphate which traps it inside the cell

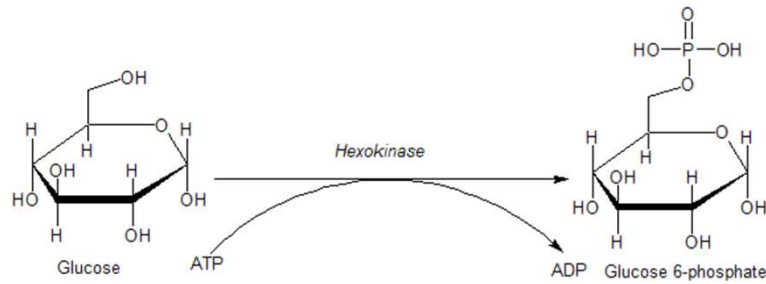

Image from [Jmun7616](#)



Western Oregon  
UNIVERSITY

If you have a disability that may require some accommodation in order to participate in a WOU activity, please notify Disability Services at 503-838-8250 or [ods@wou.edu](mailto:ods@wou.edu) at least 72 hours in advance.

TOGETHER WE  
SUCCEED

One of the most recent examples we've seen this term is the phosphorylation of glucose at the 6-position following entry into the cell. This is mediated by the Hexokinase enzyme.



## What is NTP Currency Used For?

- Enzymatic Reactions (Energy Potential)
- Phosphate Donor (Kinase-specific Reactions)
- **Cellular signaling pathways (movement; messengers)**
- Neuronal Signaling
- Movement
  - Molecular level
    - Across membranes
    - Internally through the cell (through cytoplasm; transfer to organelle)
    - Assembly of structures (ribosome; signaling complexes, etc)
  - Gross motor level (muscle contraction)



Western Oregon  
UNIVERSITY

If you have a disability that may require some accommodation in order to participate in a WOU activity, please notify Disability Services at 503-838-8250 or ods@wou.edu at least 72 hours in advance.

TOGETHER WE  
SUCCEED

Cellular signaling pathways require NTPs for a multitude of functions, including the movement of receptors, or receptor activated proteins within the plasma membrane, the generation of second messengers, and the phosphorylation of downstream targets to name a few.

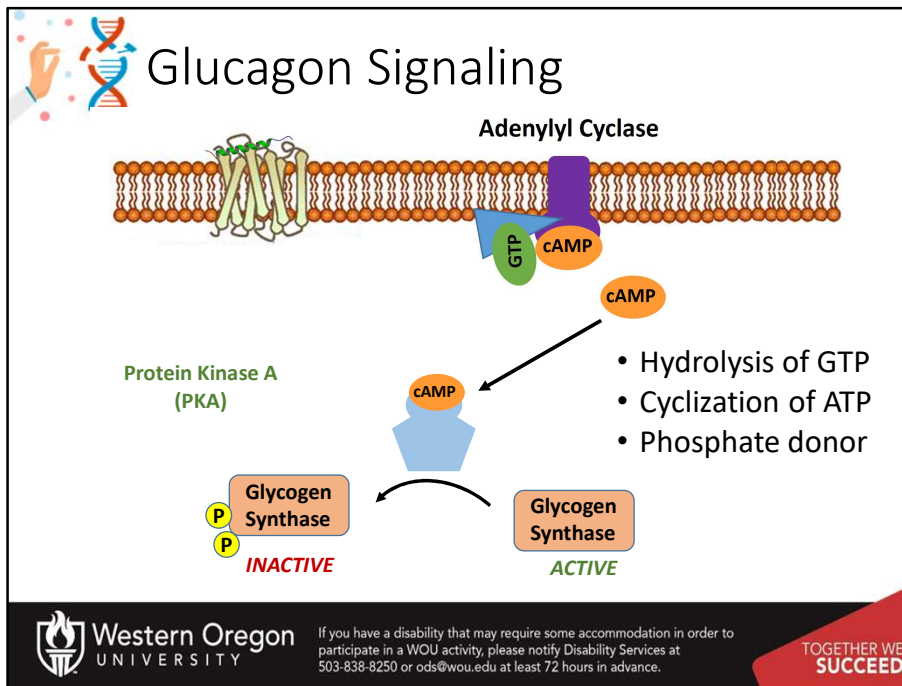

This has been exemplified most recently in the glucagon signaling pathway that utilized a G-protein bound to GTP to activate the adenylyl cyclase enzyme that generates the cAMP molecule from ATP. The second messenger, cAMP, activates a cascade of downstream kinase enzymes such as PKA that utilize ATP as a phosphate donor within the reaction mechanism. In fact, I don't believe that I know of a signaling cascade that doesn't utilize multiple NTPs during the process.



## What is NTP Currency Used For?

- Enzymatic Reactions (Energy Potential)
- Phosphate Donor (Kinase-specific Reactions)
- Cellular signaling pathways (movement; messengers)
- **Neuronal Signaling**
- Movement
  - Molecular level
    - Across membranes
    - Internally through the cell (through cytoplasm; transfer to organelle)
    - Assembly of structures (ribosome; signaling complexes, etc)
  - Gross motor level (muscle contraction)



Western Oregon  
UNIVERSITY

If you have a disability that may require some accommodation in order to participate in a WOU activity, please notify Disability Services at 503-838-8250 or ods@wou.edu at least 72 hours in advance.

TOGETHER WE  
SUCCEED

One of the greatest uses of NTPs within the body is to maintain the function of the brain. Neuronal signaling and other functions use roughly 20% of the bodies energy resources.

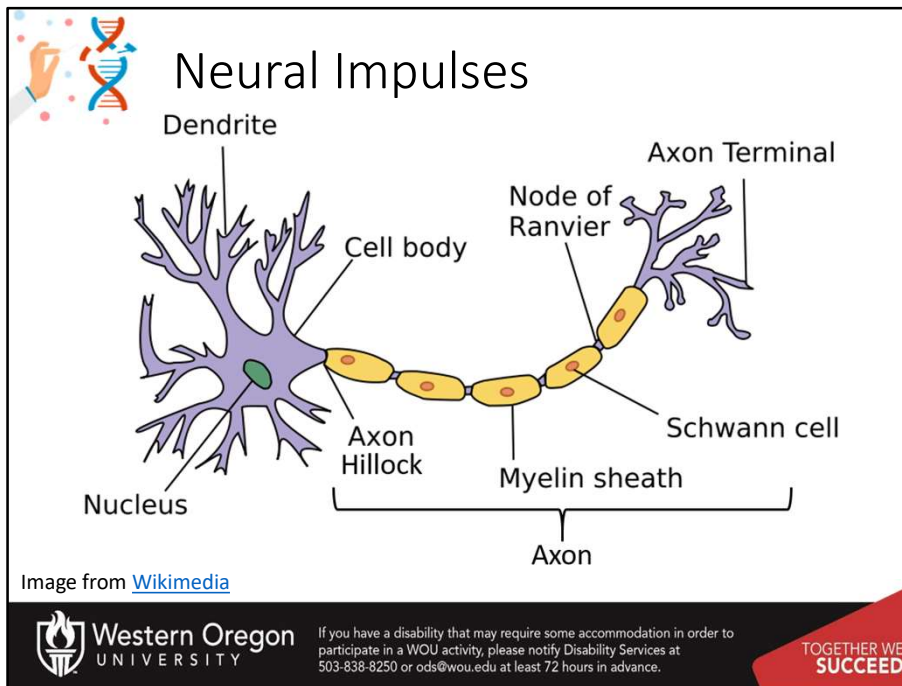

To understand the energy demands of the brain it is important to understand the structure and function of neurons. As depicted in the diagram, the neuron has a central cell body (called the **soma**) as well as **dendrite** and **axon** projections. The **dendrites** of a neuron are typically where outside signals are received and the **axon** is used to transmit the chemical signal to downstream target cells in the communication pathway. Interestingly, the cell bodies of neurons are found in bundles called **ganglia** located within the central nervous system (or the brain and spinal cord). This means that the axon projections of neurons can be very long, a meter or more in length to reach from the base of the spinal chord all the way down to the toes. Thus, the axons of many neurons are wrapped by small cells, called **Schwann cells** in the peripheral nervous system. **Schwann cells** contain a large amount of plasma membrane, allowing the cells to wrap themselves around the axon, forming a lipid insulator known as a **myelin sheath**. Damage to these sheath forming cells can lead to the loss of myelination and cause disease states such as multiple sclerosis.



## Action Potential

- Activation at dendrites
- Opening of receptor channels
- Opening of voltage gated channels
- + Electric impulse sent down axon (Cationic impulse of Na<sup>+</sup>)
- Release of Neurotransmitters into synaptic cleft

Image from [Wikimedia](https://www.wikimedia.org/)

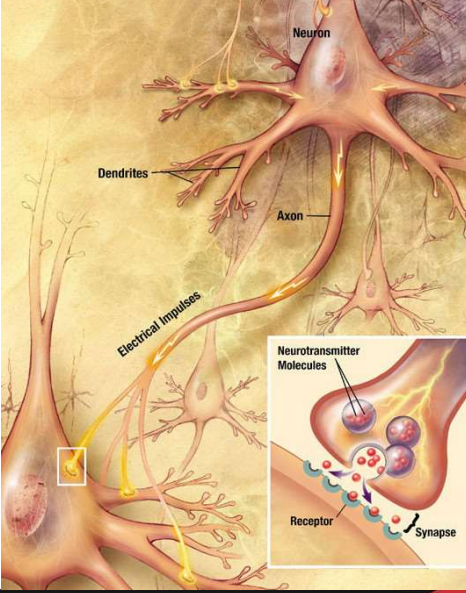



**Western Oregon**  
UNIVERSITY

If you have a disability that may require some accommodation in order to participate in a WOU activity, please notify Disability Services at 503-838-8250 or ods@wou.edu at least 72 hours in advance.

TOGETHER WE  
SUCCEED

Neurons engage in cell-cell communication by sending positive electrical signals called ***action potentials*** down the axon projection to the axon terminal. Once at the terminal, the ***action potential*** initiates the fusion of secretory vesicles with the plasma membrane and the release of ***neurotransmitters*** into the ***synaptic cleft***, or small space in between the axon terminal and the downstream target cell. ***Neurotransmitters*** are small organic molecules that interact with receptors on the dendrite or soma of the post-synaptic neuron and can either inhibit or activate further action in the downstream target cell.



## Charge Potential vs Resting State

- To set up signaling potential within an axon that is strong enough to elicit a response (ie neurotransmitter release), it must be negative inside during its resting state.
- This will allow a positive ripple to be sent through it (action potential).

 **Western Oregon**  
UNIVERSITY

If you have a disability that may require some accommodation in order to participate in a WOU activity, please notify Disability Services at 503-838-8250 or ods@wou.edu at least 72 hours in advance.

**TOGETHER WE  
SUCCEED**

For this positive electrical signal to be propagated through a neuron and down the axon, the neuron is required to set up a signaling potential within the cell. This involves setting up a concentration gradient of positive  $\text{Na}^+$  ions outside the cell and positive  $\text{K}^+$  ions inside the cell. In addition, the overall resting state most neurons is highly negative compared to the extracellular matrix with a resting potential near -70 millivolts. The major energy usage of the neuron is in maintaining and resetting the resting state of neuron after an action potential has occurred. We will investigate the mechanism used to form the  $\text{Na}^+$  and  $\text{K}^+$  concentration gradients.



## Na<sup>+</sup>/K<sup>+</sup> ATPase Pump

- Achieves the negative resting state of the neuron
- possible to send a positive electric charge

Image modified from [BruceBlaus](#)



**Western Oregon**  
UNIVERSITY

If you have a disability that may require some accommodation in order to participate in a WOU activity, please notify Disability Services at 503-838-8250 or ods@wou.edu at least 72 hours in advance.

**TOGETHER WE  
SUCCEED**

To set up the concentration gradients, the membrane of neurons contain many protein pumps that generate concentration gradients of ions on the outside and inside of the cell. The primary pump is called the Sodium-Potassium ATPase Pump. The Na<sup>+</sup>/K<sup>+</sup> ATPase Pump uses the energy of ATP to pump 3 Na<sup>+</sup> out the cell and 2 K<sup>+</sup> into the cell for every ATP molecule that is hydrolyzed. Thus, chemical gradients occur with high concentrations of Na<sup>+</sup> outside of the cell and high concentrations of K<sup>+</sup> inside the cell. Chemical gradients hold a lot of potential energy. You can think of it like creating a dam that contains water. When water is released from the dam, gravity will cause the water to flow from the dam at a high rate, releasing energy that can be used to do work, such as generating electricity. Similarly, when a concentration gradient of ions is released, it will flow down its concentration gradient to areas in low supply and release lots of energy in the process. It is the flow of these ions from one location to another that allow the generation of an action potential within the neuron.

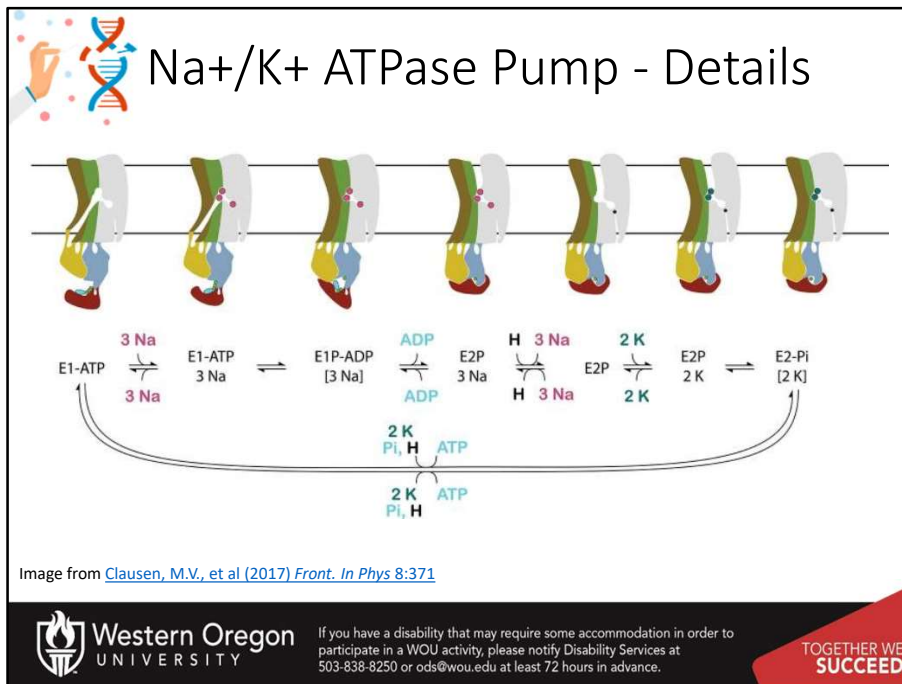

This diagram shows the action of the Na<sup>+</sup>/K<sup>+</sup> ATPase pump in more detail. This pump acts as a carrier protein, rather than a channel protein. That means that rather than forming a pore where molecules can flow to the other side, this protein works to carry molecules from one side to the other by shifting into different structural conformations. The pump begins by binding with a molecule of ATP, creating an E1-ATP complex indicated above. In the E1 state, there is an opening to the cytoplasmic side of the cell. Three Na<sup>+</sup> ions from the cytoplasm join the complex causing an alteration in protein structure such that the cytoplasmic opening is now blocked and the Na<sup>+</sup> ions are trapped inside. This triggers the hydrolysis of ATP to ADP. Dissociation of ADP causes the pump to change conformation into the E2 state, opening the pump towards the extracellular side and releasing the three Na<sup>+</sup> ions. Two K<sup>+</sup> ions from the extracellular side bind in the cleft, and the cleft closes. ATP association with the E2P-2K<sup>+</sup>, causes the release of the K<sup>+</sup> into the cytoplasm and the enzyme is reset for another round. Once the Na<sup>+</sup> and K<sup>+</sup> gradients are created, the neuron is ready to activate an action potential. This can be accomplished within 2-3 milliseconds.

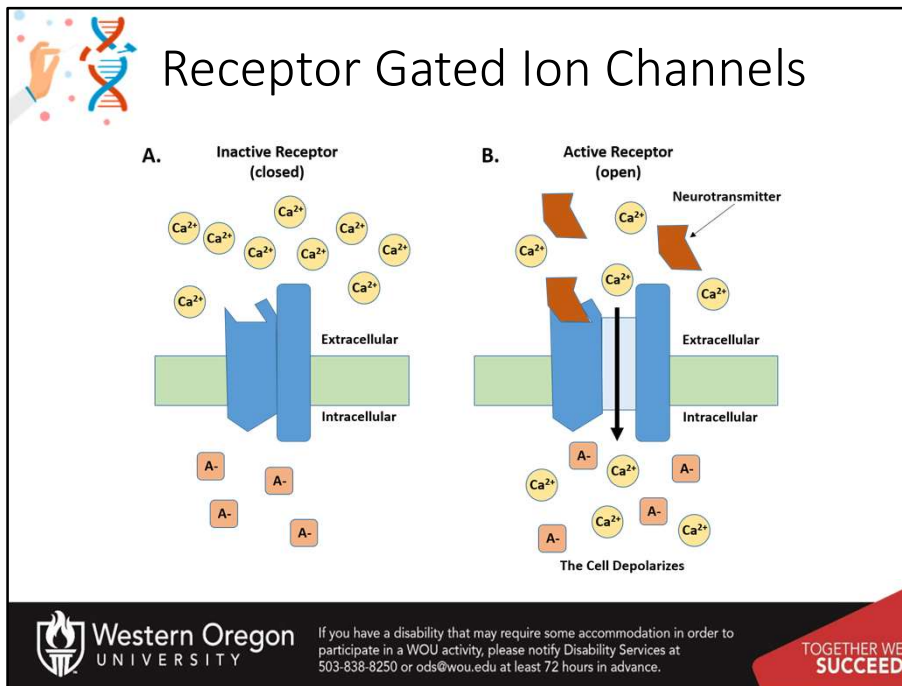

Once the ion gradients are set up, an action potential can be generated within a neuron. This begins when a neurotransmitter from an upstream neuron is released into the synaptic cleft resulting in the binding of the neurotransmitter to the **Receptor-Activated Ion Channels** on the target neuron. The diagram shows in part (A) a receptor in the closed conformation during the resting state of the neuron. Note that similar to sodium, calcium ions are also in high concentration outside of the cell. When neurotransmitters are released from the axon into the synapse, they will bind with the receptor causing a conformational change in the receptor that opens the calcium ion channel.  $\text{Ca}^{2+}$  flows into the cell down its concentration gradient causing localized depolarization within the cell.

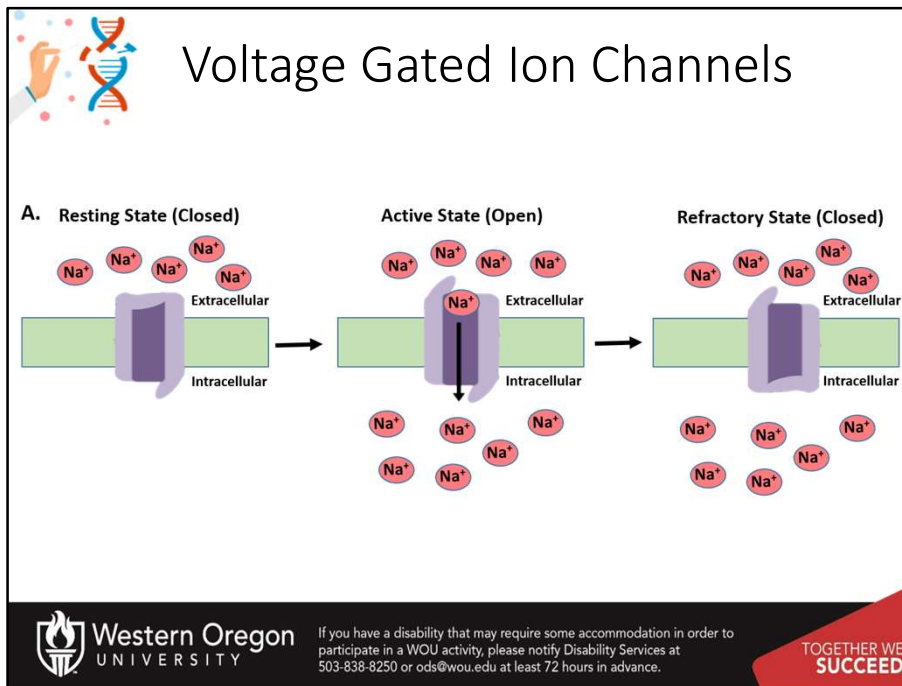

As the neuron moves towards a neutral charge state in that localized area, the **Voltage-Gated Sodium Channels** undergo a conformational change, opening the sodium channel and allowing the influx of Na<sup>+</sup> into the cell. When the cellular charge overshoots and becomes positive (approximately +30 mV) the voltage-gated Na<sup>+</sup> channels close due to an additional conformation change and enters what is called an **absolute refractory period** where they cannot be reactivated to send an additional action potential. If the depolarization signal is strong enough, the activation of sodium channels will lead to the activation of other downstream voltage-gated sodium channels and thereby propagate the signal down the dendrites and through the cell body towards the axon. The **absolute refractory period** of the voltage-gated sodium channels keeps the signal from going backwards.

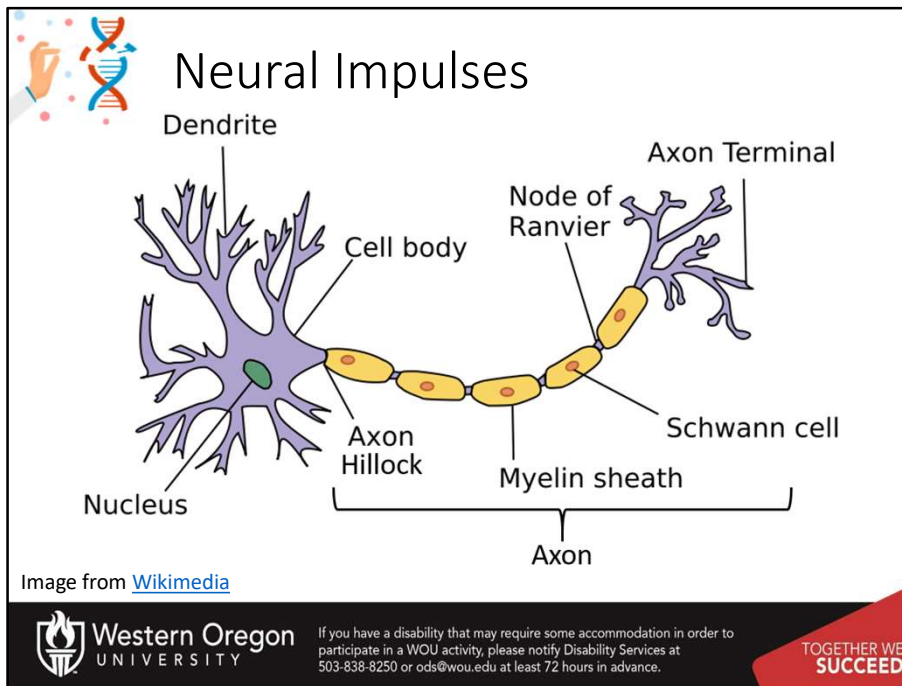

If a depolarization event of at least -55 mV, reaches the **axon hillock** located at the top of the axon, then an action potential will be sent to the downstream target cell. Action potentials sent down the axon are all or nothing. Once the axon hillock has reached the threshold potential, the neuron is now committed to sending the signal to the neighboring cell.

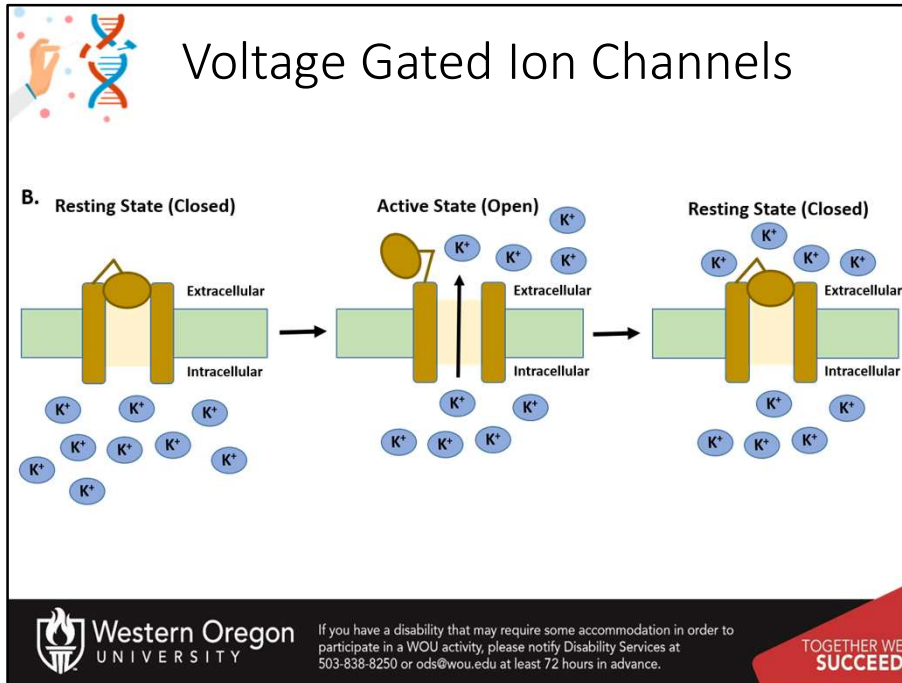

So what happens after depolarization? The voltage-gated potassium channels are also present within the plasma membrane of neurons. They are closed during the resting state of the neuron and do not open until the polarity of the cell shifts to approximately +30 mV. Following activation, potassium ions move out of the cell, down their concentration gradient and restore the resting potential of the neuron to -70 mV. This charge state within the neuron resets the resting state conformation of the voltage-gated  $Na^+$  and  $K^+$  channels, and the **absolute refractory period** has passed. However, a full depolarization event cannot be generated again until the ion gradients are also reset. These gradients are restored by the  $Na^+/K^+$  ATPase.

**Na<sup>+</sup>/K<sup>+</sup> ATPase Pump**

- Resets the resting potential of the neuron between action potentials

Image modified from [BruceBlaus](#)

Western Oregon UNIVERSITY

If you have a disability that may require some accommodation in order to participate in a WOU activity, please notify Disability Services at 503-838-8250 or ods@wou.edu at least 72 hours in advance.

TOGETHER WE SUCCEED

The period of time that it takes the Na<sup>+</sup>/K<sup>+</sup> ATPase to restore the Na<sup>+</sup> and K<sup>+</sup> gradients after a depolarization event is called the **relative refractory period**. During the relative refractory period a new signal CAN be sent, however, it will not be as strong as normal, because sodium movement into the cell and therefore, depolarization, will be minimal until the gradient is also restored.

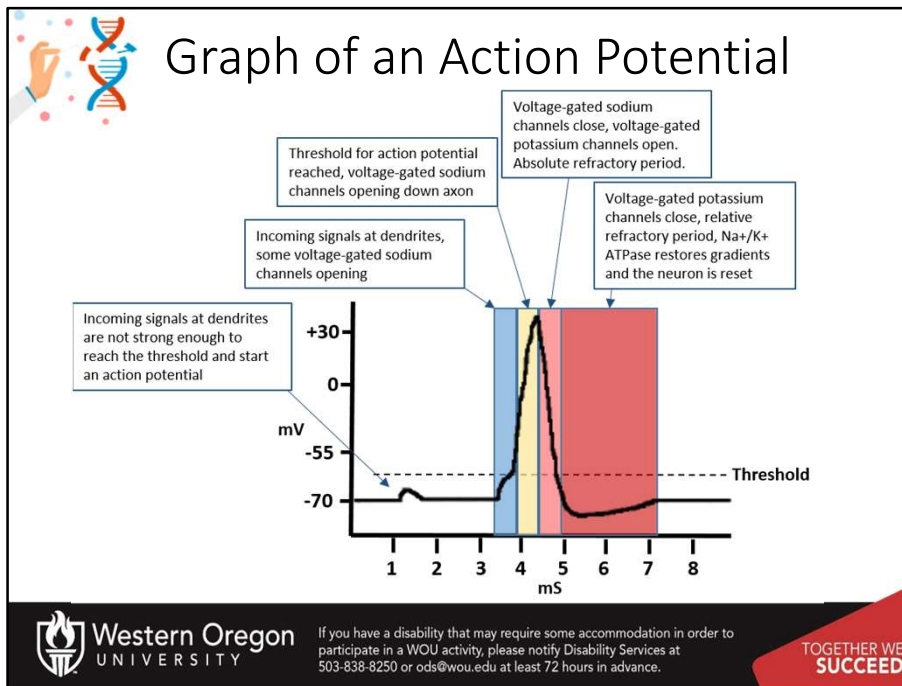

This is a Graphic Representation of an Action Potential. The resting state potential of a neuron is -70 mV. If signaling at the dendrites is large enough, an action potential is propagated down an axon. This occurs when a threshold of -55 mV reaches the **axon hillock**, which is located at the base of the axon in the cell body. This causes the opening of voltage-gated sodium channels along the axon and the release of neurotransmitter from the axon terminal. The voltage-gated sodium channels close and become refractory when the cell potential reaction +30 mV. This also results in the opening of the voltage-gated potassium channels which re-establish the resting state potential of the neuron to -70 mV. The Na<sup>+</sup>/K<sup>+</sup> ATPase Pump restores the Na<sup>+</sup> and K<sup>+</sup> gradients within the neuron during the relative refractory period and enables the neuron to fully reset and fire another action potential.





## Brain Function

- Uses ~ 20% of the body's energy

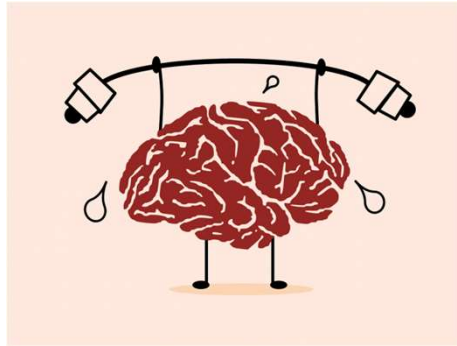

Image from [Pixabay](#)



Western Oregon  
UNIVERSITY

If you have a disability that may require some accommodation in order to participate in a WOU activity, please notify Disability Services at 503-838-8250 or [ods@wou.edu](mailto:ods@wou.edu) at least 72 hours in advance.

TOGETHER WE  
SUCCEED

Overall, brain function requires approximately 20% of the body's energy. Most of this energy is used to reset the  $\text{Na}^+$  and  $\text{K}^+$  gradients following a depolarization event. However, in the next section we will also see that neurons can also have high energy demands to move neurotransmitters from the cell body down to the axon terminal.